

## INTRODUCTION

Thank you for choosing an HK Instruments CDT2000 Duct series carbon dioxide transmitter. The CDT2000 Duct series is intended for use in commercial environments in HVAC/R applications.

The CDT2000 Duct series measures carbon dioxide (CO<sub>2</sub>), utilizing the industry standard NDIR measurement principle, and temperature (T). Illuminated display ensures easy readability also from a distance. The CDT2000 Duct has a screwless lid and an easily adjustable mounting flange that make the installation of the device easy.

The CDT2000 Duct series transmitters calibrate themselves automatically using ABC™ logic. The ABC™ logic requires that the space in which the transmitter is used needs to be unoccupied for four hours per day so that the indoor CO<sub>2</sub> concentration drops to the outside level. CDT2000-DC Duct is a dual channel model with a measuring channel and a reference channel that makes a continuous comparison and the necessary adjustment accordingly. CDT2000-DC Duct is also suitable for buildings that are continuously occupied.

## APPLICATIONS

CDT2000 Duct series devices are commonly used to monitor:

- CO<sub>2</sub> levels of incoming and return air in ventilation system
- CDT2000-DC Duct series devices can also be used in applications where there is a constant source of carbon dioxide present (for example hospitals and greenhouses)

## SPECIFICATIONS

### Performance

**Measurement ranges:**CO<sub>2</sub>: 400–2000 ppm

Temperature: 0...50 °C / 32...122 °F □

**Accuracy:**CO<sub>2</sub>: ±40 ppm + 2 % of reading, DC model: 75 ppm or 10 % of reading (whichever is greater)

Temperature: &lt;0.5 °C / &lt;0.9 °F □

### Technical Specifications

**Media compatibility:**

Dry air or non-aggressive gases

**Measuring units:**

ppm and °C

**Measuring element:**CO<sub>2</sub>: Non-dispersive infrared (NDIR)

Temperature: NTC10K

**Calibration:**

Automatic self-calibration ABC Logic™ or continuous comparison (DC)

**Environment:**

Operating temperature: 0...50 °C / 32...122 °F □

Storage temperature: -20...70 °C / -4...158 °F □

Humidity: 0 to 95 % rH, non condensing

### Physical

**Dimensions:**

Case: 119 x 100 x 44.7 mm / 4.69 x 3.94 x 1.76" □

Probe: L=188 mm, d=12 mm / L=7.40", d=0.47" □

**Mounting:**

With flange, adjustable 0...188 mm / 0...7.40" □

**Weight:**

150 g / 5.30 oz □

**Materials:**

Case: ABS

Cover: PC

Probe: ABS

**Protection standard:**

IP54

**Electrical connections:**

4 spring loaded terminals

(24 V, GND, CO<sub>2</sub>, T)0.2–1.5 mm<sup>2</sup> (12–24 AWG)

## WARNING

- READ THESE INSTRUCTIONS CAREFULLY BEFORE ATTEMPTING TO INSTALL, OPERATE OR SERVICE THIS DEVICE.
- Failure to observe safety information and comply with instructions can result in PERSONAL INJURY, DEATH AND/OR PROPERTY DAMAGE.
- To avoid electrical shock or damage to equipment, disconnect power before installing or servicing and use only wiring with insulation rated for full device operating voltage.
- To avoid potential fire and/or explosion do not use in potentially flammable or explosive atmospheres.
- Retain these instructions for future reference.
- This product, when installed, will be part of an engineered system whose specifications and performance characteristics are not designed or controlled by HK Instruments. Review applications and national and local codes to assure that the installation will be functional and safe. Use only experienced and knowledgeable technicians to install this device.

### Electrical

Supply voltage: 24 VAC or VDC ±10 %

Current consumption: max 230 mA (at 24 V) + 10 mA for each voltage output

Output signals for every media:

0/2...5/10 VDC, Load R minimum 1 kΩ

### Conformance

Meets requirements for CE marking:

EMC Directive 2014/30/EU

RoHS Directive 2011/65/EU

WEEE Directive 2012/19/EU

COMPANY WITH  
MANAGEMENT SYSTEM  
CERTIFIED BY DNV GL  
= ISO 9001 = ISO 14001 =



## SCHEMATICS

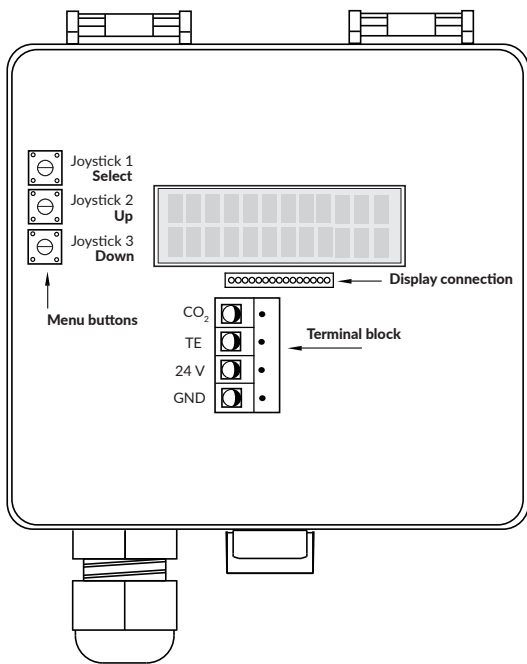

## DIMENSIONAL DRAWINGS

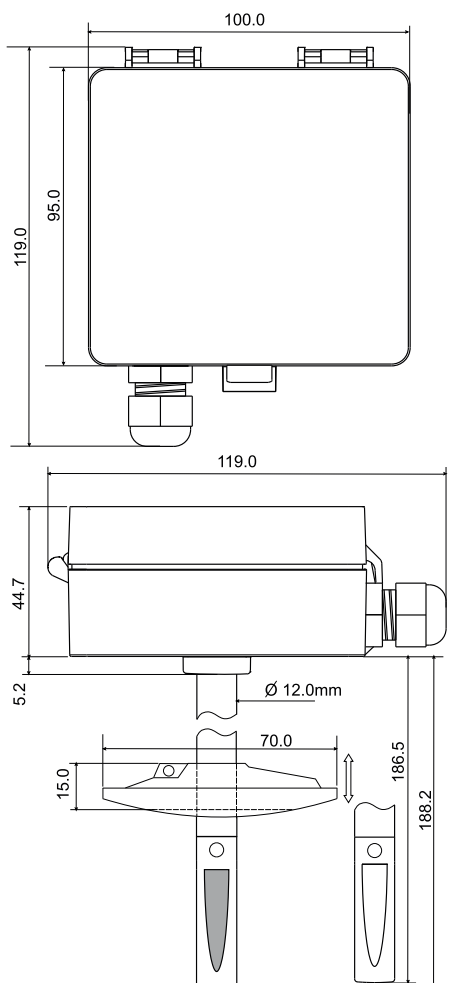

## INSTALLATION

- 1) Mount the device in the desired location (see step 1).
- 2) Route the cables and connect the wires (see step 2).
- 3) The device is now ready for configuration.

**⚠ WARNING!** Apply power only after the device is properly wired.

### STEP 1: MOUNTING THE DEVICE

- 1) Select the mounting location (on a duct).
- 2) Use the mounting flange of the device as a template and mark the screw holes.
- 3) Mount the flange on the duct with screws (not included). (Figure 1a)
- 4) Adjust the probe to the desired depth. Ensure that the end of the probe reaches the middle of the duct. (Figure 1b)
- 5) Tighten the screw on the flange to hold the probe in position.

Figure 1a - Mounting a flange

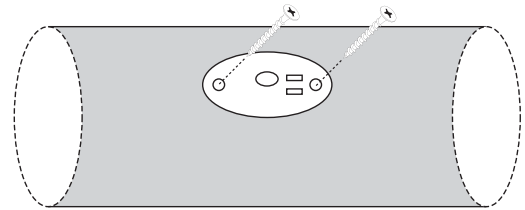

Figure 1b - Mounting the probe in a flange

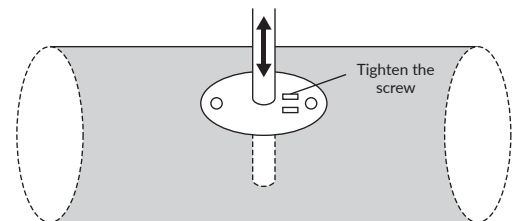
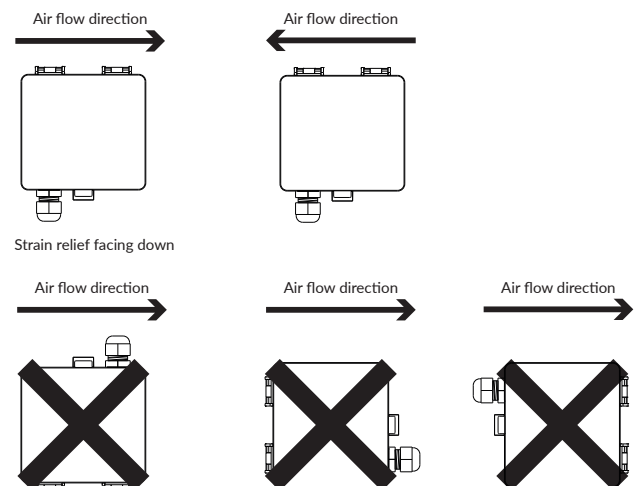

Figure 1c - Mounting orientation



## STEP 2: WIRING DIAGRAMS

For CE compliance a properly grounded shielding cable is required.

- 1) Unscrew the strain relief and route the cable(s).
- 2) Connect the wires as shown in figure 2a.
- 3) Tighten the strain relief.

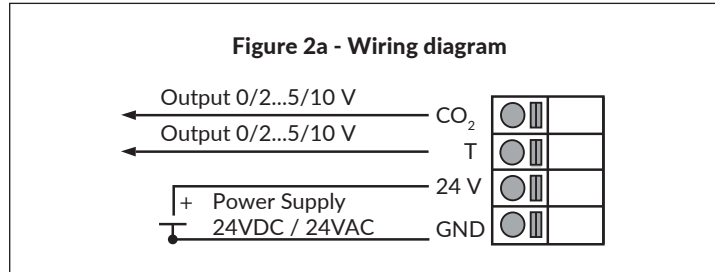

NOTE! When using long connection wires it may be necessary to use a separate GND wire for voltage output current to prevent measurement distortion. The need for an extra GND wire depends on the cross section and length of the used connection wires. If long and/or small cross section wires are used, supply current and wire resistance may generate a voltage drop in the common GND wire resulting in a distorted output measurement.

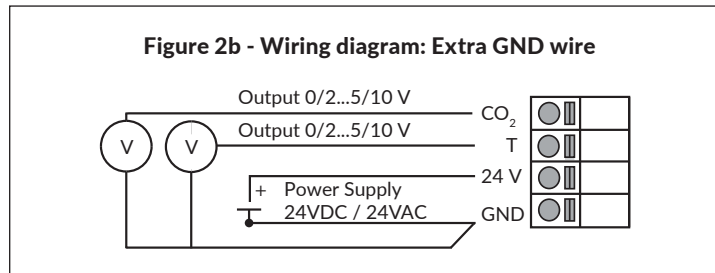

## STEP 3: CONFIGURATION

Configuration of the CDT2000 Duct series device consists of: Configuration menu options. (Display versions only.) Press the select button to accept changes. Move to the next setting by pressing the down button.

- 1) Activate the device Menu by pushing the select button for 2 seconds.
- 2) Select the CO<sub>2</sub> low limit for output band: 0...1900 ppm.

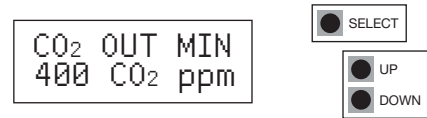

- 3) Select the CO<sub>2</sub> high limit for output band: 500...2000 ppm.

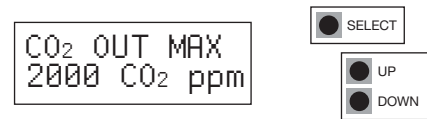

- 4) Select the temperature low limit for output band: 0...45.0 °C or 32...112 °F.



- 5) Select the temperature high limit for output band: 5...50.0 °C or 42...122 °F.



- 6) Select the output maximum voltage: 5 V / 10 V.

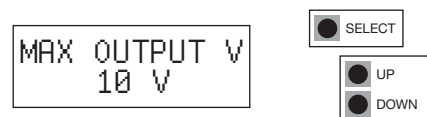

- 7) Select the output minimum voltage: 0 V / 2 V.

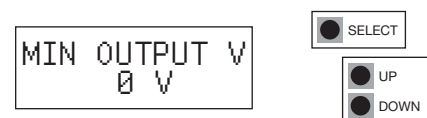

- 8) Push the select button to exit menu.



## RECYCLING/DISPOSAL

The parts left over from installation should be recycled according to your local instructions. Decommissioned devices should be taken to a recycling site that specializes in electronic waste.



## WARRANTY POLICY

The seller is obligated to provide a warranty of five years for the delivered goods regarding material and manufacturing. The warranty period is considered to start on the delivery date of the product. If a defect in raw materials or a production flaw is found, the seller is obligated, when the product is sent to the seller without delay or before expiration of the warranty, to amend the mistake at his/her discretion either by repairing the defective product or by delivering free of charge to the buyer a new flawless product and sending it to the buyer. Delivery costs for the repair under warranty will be paid by the buyer and the return costs by the seller. The warranty does not comprise damages caused by accident, lightning, flood or other natural phenomenon, normal wear and tear, improper or careless handling, abnormal use, overloading, improper storage, incorrect care or reconstruction, or changes and installation work not done by the seller or his/her authorized representative. The selection of materials for devices prone to corrosion is the buyer's responsibility, unless otherwise is legally agreed upon. Should the manufacturer alter the structure of the device, the seller is not obligated to make comparable changes to devices already purchased. Appealing for warranty requires that the buyer has correctly fulfilled his/her duties arisen from the delivery and stated in the contract. The seller will give a new warranty for goods that have been replaced or repaired within the warranty, however only to the expiration of the original product's warranty time. The warranty includes the repair of a defective part or device, or if needed, a new part or device, but not installation or exchange costs. Under no circumstance is the seller liable for damages compensation for indirect damage.



[SELCOUSA.com](http://SELCOUSA.com)